

# Инструкция по сборке Instructions for assembling furniture Instrukcja montażu mebli

## «Серия модульных шкафов»

Корпус шкафа 51/56 P  
Cabinet cupboard 51/56 P  
Korpus szafki 51/56 P

AH-056.04.00.00

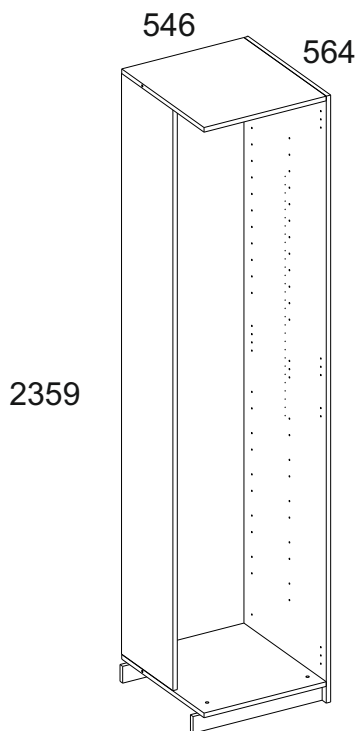

---

Дата изготовления  
Production date  
Data produkcji

---

Штамп ОТК  
Stamp of Quality Department  
Pieczęć Działu Jakości

**ИООО « АНРЭКС »**

Республика Беларусь, 224004  
г.Брест, ул. Катин Бор, 119  
тел/факс (+375162) 29-74-68



ЕАЭС №BY/112 11.01. TP025 018.01 00105  
от 15.04.2021  
по 14.04.2026

**Корпус шкафа 51/56 P**  
**Korpus szafki 51/56 P**  
**Cabinet cupboard 51/56 P**

**Элементы для докупки**  
**Dodatkowe elementy do zakupu**  
**Additional elements for buying**

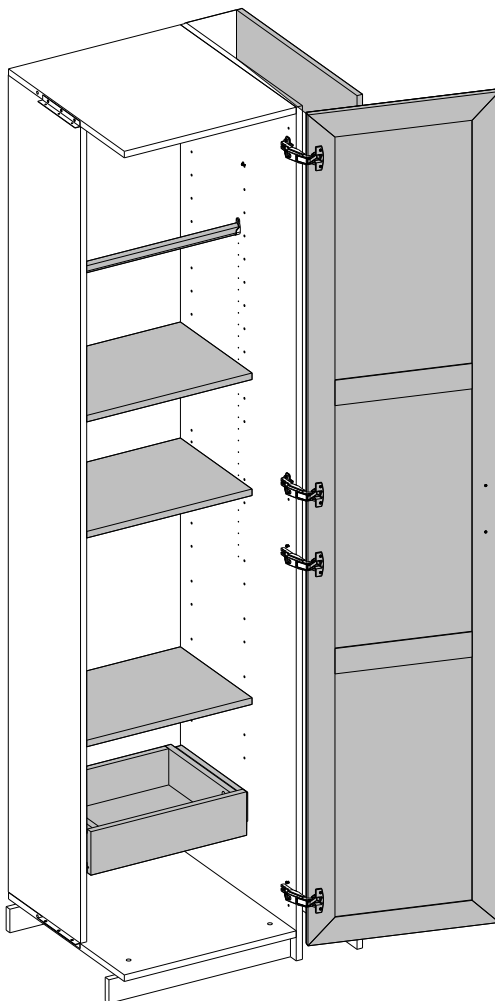
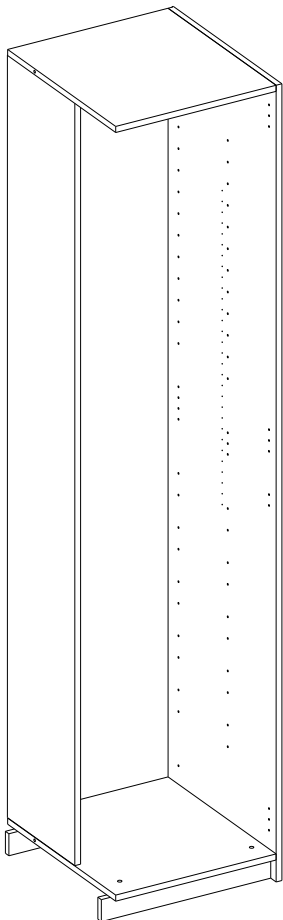

**Элементы для докупки**  
**Dodatkowe elementy do zakupu**  
**Additional elements for buying**

Комплект полок 51/35  
Zestaw półek 51/35 AH-056.13.00.00  
Set of shelves 51/35

Ящик 51/35  
Szuflada 51/35 AH-056.18.00.00  
Drawer 51/35

Дверь 50 Z  
Drzwi 50 Z AH-056.19.00.00  
Frontage 50 Z

Дверь 50 (F1-1)  
Drzwi 50 (F1-1) AH-056.20.00.00  
Frontage 50 (F1-1)

Дверь 50 (F1-2)  
Drzwi 50 (F1-2) AH-056.21.00.00  
Frontage 50 (F1-2)

Накладка 56  
Nakładka 56 AH-056.30.00.00  
Overlay 56

Штанга 51/56  
Sztanga 51/56  
Crossbar 51/56

### **Инструкция по эксплуатации.**

Качество и комплектность изделия рекомендуется проверять в магазине при покупке в распакованном виде. Сборка изделия должна производиться в порядке, изложенном в настоящей инструкции. В процессе эксплуатации изделий необходимо периодически затягивать ослабленные винтовые соединения. В случае необходимости перемещения изделия по квартире перед его перестановкой, необходимо полностью освободить его от груза (матраца). Во избежание поломки имеющихся опор передвигать производить приподнимая изделие над уровнем пола. Запрещён прямой контакт с водой. Удаление пыли с изделий следует производить слегка влажной мягкой салфеткой. Во избежание коробления деталей и изменения цвета изделия следует избегать установки мебели на прямых солнечных лучах.

При эксплуатации изделий набора **ЗАПРЕЩАЕТСЯ:**

- устанавливать мебель вблизи отопительных приборов и вплотную к сырým стенам и в помещениях с относительной влажностью более 70%;
- температура нагрева элементов мебели не должна превышать +40 °С.
- в процессе сборки и эксплуатации изделий набора становиться ногами на горизонтальные щиты и витрины;
- применять химические чистящие средства для уборки мебели;

#### **Гарантии изготовителя.**

1. Гарантийный срок эксплуатации изделия - 24 месяца со дня продажи магазином. В период гарантийного срока изготовитель гарантирует ремонт изделий или их замену, если потребителем не нарушены правила эксплуатации.
2. Претензии предъявляются потребителем непосредственно в торгующую организацию, в которой была приобретена мебель, предъявив настоящую "Инструкцию по сборке" и копию товарного чека.
3. Изделие **Корпус шкафа 51/56 Р**, входящее в состав набора мебели для общей комнаты **«Серия модульных шкафов»**, соответствует требованиям ГОСТ 16371-2014, ТР ТС 025/2012.
4. Срок службы мебели - 5 лет.
5. Предприятие-изготовитель оставляет за собой право вносить изменения в конструкцию изделия, не ухудшая его конструктивные и эксплуатационные характеристики.
6. Для сборки изделий рекомендуется привлекать квалифицированных специалистов.

#### **Запах.**

От новой мебели может исходить запах материалов, из которых она изготовлена. Запах может сохраняться в течение трёх недель с момента сборки. Для снижения интенсивности запаха рекомендуется:

-для мягкой мебели - пропылесосить изделие и проветрить помещение.

Повторять 3-4 раза в день.

-для корпусной мебели – протирать тканью, смоченной мягким моющим средством, вытирать чистой сухой тканью и проветривать помещение, предварительно открывая все двери и ящики изделия.

Повторять 3-4 раза в день.

**Важно!** Сохраните, пожалуйста, инструкцию в случае повторной сборки мебели или рекламации. В случае составления рекламации пользуйтесь, пожалуйста, обозначением из инструкции сборки.

**PL****Przy eksploatacji mebli zabrania się:**

- ustawiać meble w pobliżu grzewczych przyrządów i obok wilgotnych ścian, a także w pomieszczeniach ze względną wilgotnością więcej niż 70%;
- temperatura nagrzewania elementów mebli nie może przekraczać +40°C;
- w trakcie montażu i eksploatacji mebli stawać nogami na poziome panele i witryny;
- stosować chemiczne środki czyszczące do sprzątania mebli;
- nie należy narażać na kontakt z wodą.

**Gwarancje producenta.**

1. Gwarancyjny termin eksploatacji wyrobu - 24 miesiące z dnia sprzedaży. W okresie gwarancyjnego terminu producent gwarantuje naprawę wyrobów lub ich zamianę, jeżeli reguły eksploatacji nie zostały naruszone przez nabywcę.
2. Roszczenia są przekazywane przez nabywcę bezpośrednio do handlującej organizacji, w której były nabyte meble, tylko przy okazaniu danej "Instrukcji montażu" wraz z dokumentem zakupu.
3. Wyrób **Korpus szafki 51/56 P**, wchodzące w zestaw mebli **«Seria modułowych szaf»**, odpowiada wymaganiom Norm Państwowych 16371-2014, TP TC 025/2012.
4. Trwałość użytkowa mebli - 5 lat.
5. Firma-producent pozostawia za sobą prawo do wprowadzania zmian w konstrukcje wyrobów, nie pogarszając ich konstruktywne i eksploatacyjne charakterystyki.
6. Do montażu wyrobów zaleca się skorzystanie z pomocy wykwalifikowanych specjalistów.

**Zapach.**

Nowe meble mogą wydzielać zapach materiałów, z których są wykonane. Zapach może utrzymywać się do trzech tygodni od momentu montażu. Aby zmniejszyć intensywność zapachu, zaleca się:

- w przypadku mebli tapicerowanych - odkurzyć produkt i przewietrzyć pomieszczenie. Powtarzaj 3-4 razy dziennie.
- dla mebli szafkowych - przetrzyj ściereczką zwilżoną łagodnym detergentem, przetrzyj czystą, suchą ściereczką i przewietrz pomieszczenie, uprzednio otwierając wszystkie drzwi i szuflady produktu. Powtarzaj 3-4 razy dziennie.

**Ważne!** Proszę zachować instrukcję w razie ponownego montażu mebli lub reklamacji. Podczas składania reklamacji prosimy o korzystanie z oznaczeń z instrukcji.

**EN****Instruction manual.**

It's advised to check the quality and completeness of the product in the store when buying unpacked. Assembling of the product should be done the way it's described in this manual. While the product is in service loose screw connections should be periodically tightened. If it's necessary to move items around the apartment before moving you should release the product completely from the load (the mattress). To prevent damage to existing supports the product should be lifted before moving. Furniture should not be exposed to contact with water. Dusting the product should be done with a slightly damp soft cloth. To prevent warping of parts and discoloration of products do not install furniture in direct sunlight.

**While the product is in service it's PROHIBITED TO:**

- Install furniture near heating devices, close to the raw walls and in rooms with a relative humidity of more than 70%;
- heat elements of furniture to the temperature higher +40°C;
- step on the horizontal shields and windows during assembly and use of the products set;
- use chemical cleaners for cleaning furniture;

**Manufacturer's warranty.**

1. The warranty period of use of the product - 24 months from the date of sale. During the warranty period the manufacturer guarantees repair or replacement of products, if the user has not violated operating rules.
2. Claims should be made by the consumer directly to the trading organization, in which furniture was purchased, presenting the "Instruction manual" and a copy of the sales receipt.
3. The product **Cabinet cupboard 51/56 P**, which is part of a set of **«Series of modular cabinets»**, meet the requirements of GOST 16371-2014, TR TS 025/2012.
4. The lifetime of furniture - 5 years.
5. The manufacturer reserves the right to make changes in product design, without compromising its design and application requirements.
6. To assemble the products it's recommended to attract qualified personnel.

**Smell.**

New furniture may emit the smell of the materials from which it is made. The smell can persist for up to three weeks from the time of assembly. To reduce odor intensity, it is recommended:







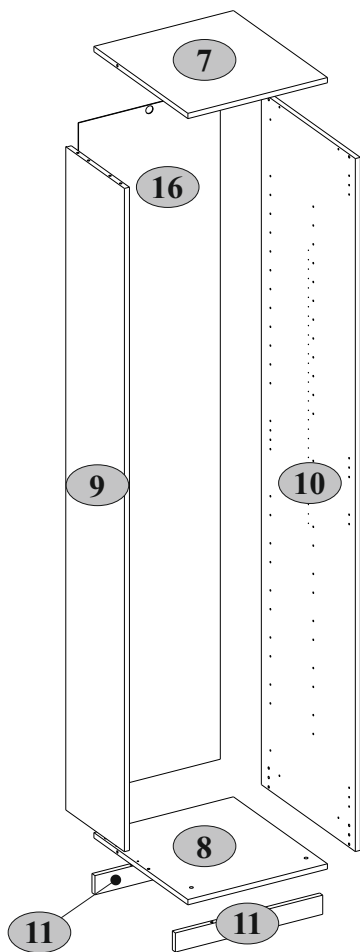
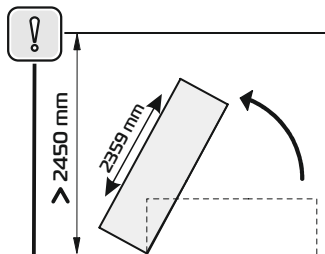
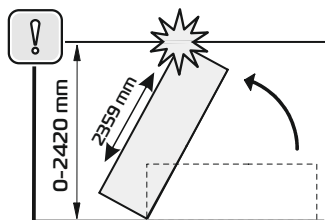
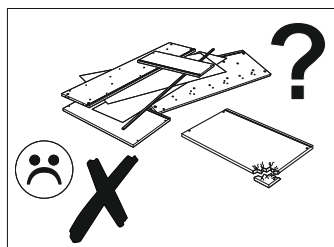





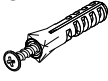
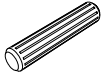
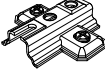

- for upholstered furniture - vacuum the product and ventilate the room. Repeat 3-4 times a day.
- for cabinet furniture - wipe with a cloth dampened in a mild detergent, wipe with a clean, dry cloth and ventilate the room, previously opening all doors and drawers of the product. Repeat 3-4 times a day.

**It is important!** Keep the instruction in case of reassembly of furniture or complaint. When making a claim use the notation from the instruction.

№ п/п	Длина, мм.	Ширина, мм.	Толщина, мм.	Кол-во, шт.	№ пачки
7	500	561	18	1	1/3
8	500	561	18	1	1/3
9	2254	350	18	1	2/3
10	2355	564	18	1	2/3
11	528	65	18	2	1/3
16	2286	508	2,5	1	2/3



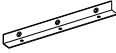

<b>A1</b>  7x34 10	<b>A2</b>  Ø15x12 10	<b>B5</b>  10x50 1	<b>C1</b>  8x35 16
<b>D1</b>  4	<b>E12</b>  165° 4	<b>I</b>  S4 1	<b>N1</b>  4
<b>N16</b>  M10 2	<b>N17</b>  L=85 2	<b>R3</b>  3x20 20	<b>R23</b>  6,3x13 8
<b>R102</b>  3,5x16 14	<b>S5</b>  Ø18 6	<b>S8-1</b>  Ø20 2	<b>U</b>  90x35x15 1
<b>U18</b>  2	<b>3/3</b>		

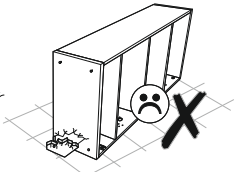
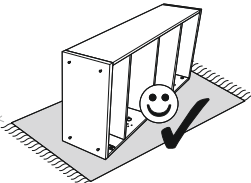
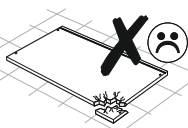
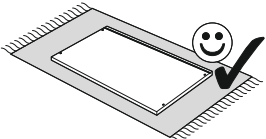
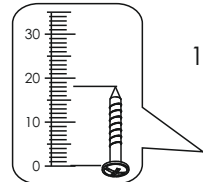
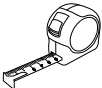
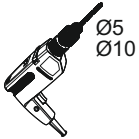
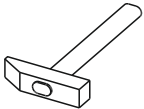
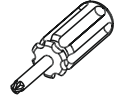
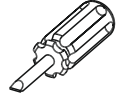
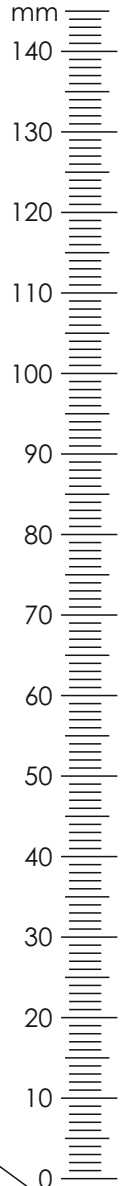

**1****A1**

7x34

4

**A2**

Ø15x12

4

**C1**

8x35

4



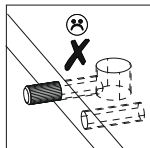
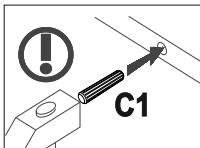
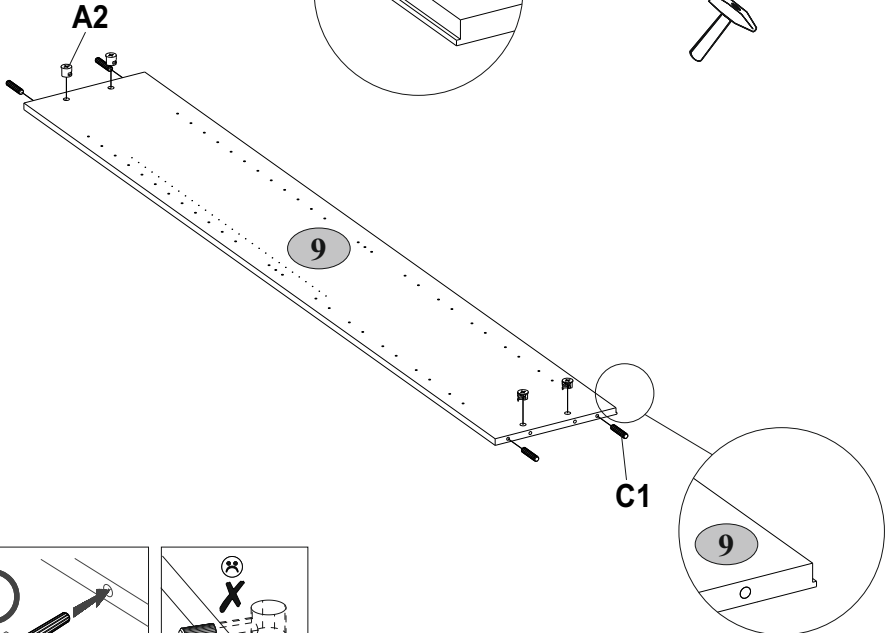
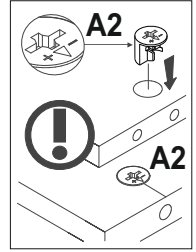
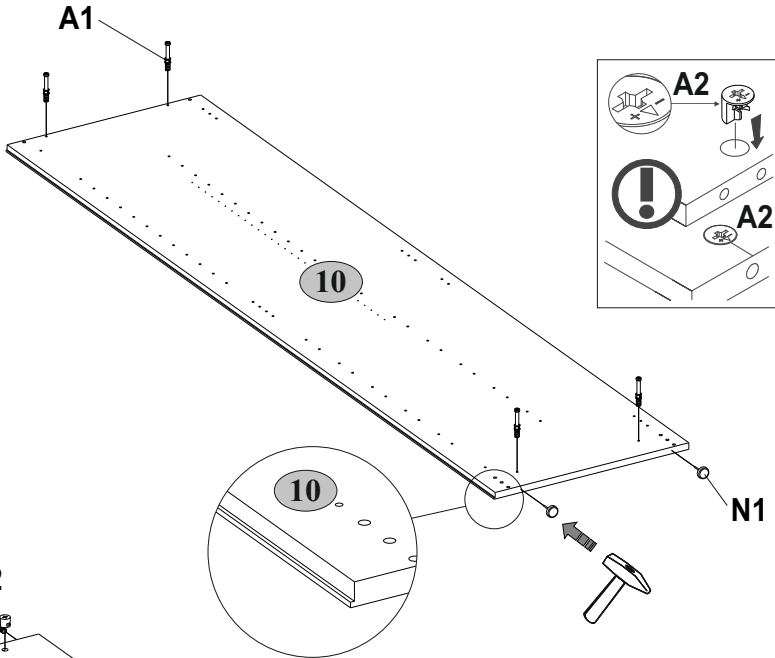
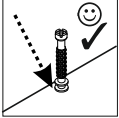
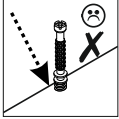
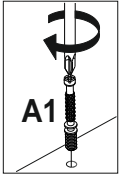

**N1**

2



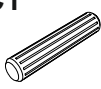

**2**

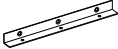
<b>A1</b>  7x34 2	<b>A2</b>  Ø15x12 4	<b>C1</b>  8x35 9	<b>N1</b>  2	<b>R102</b>  3,5x16 3
<b>U18</b>  1				

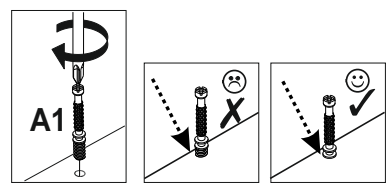
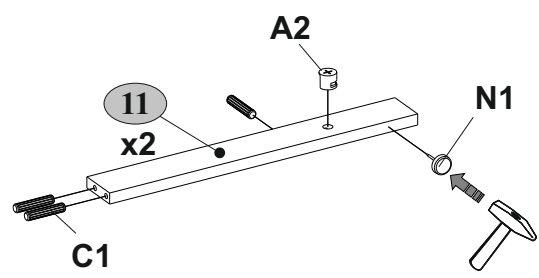
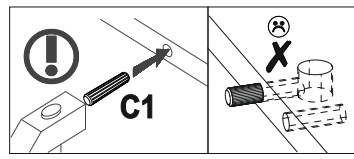
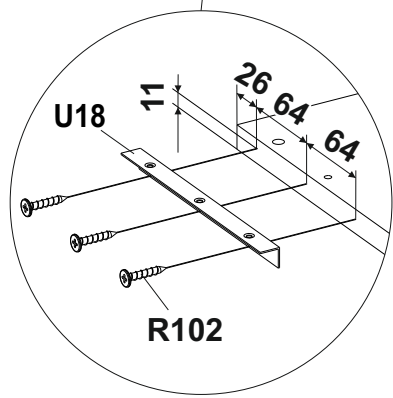
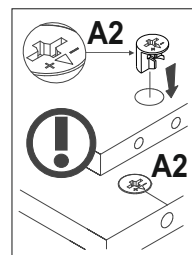
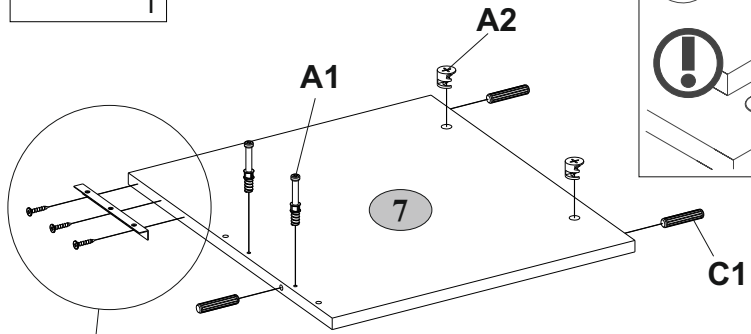

**3**

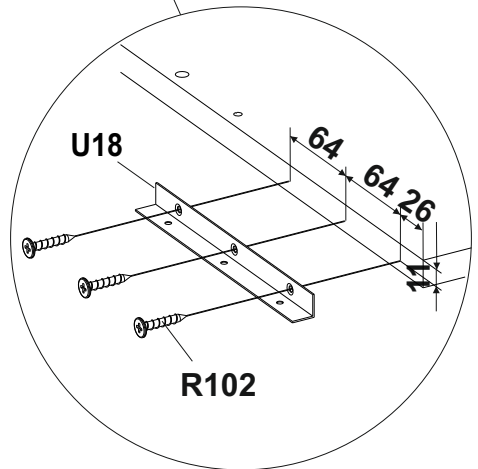
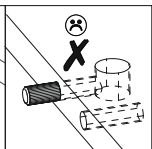
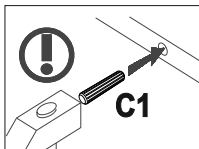
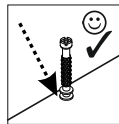
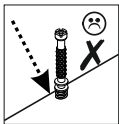
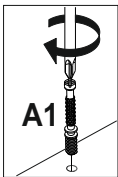
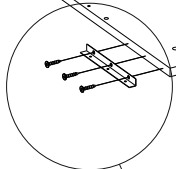
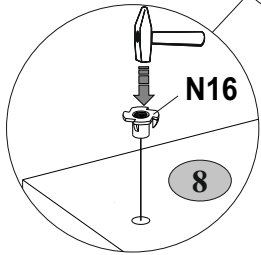
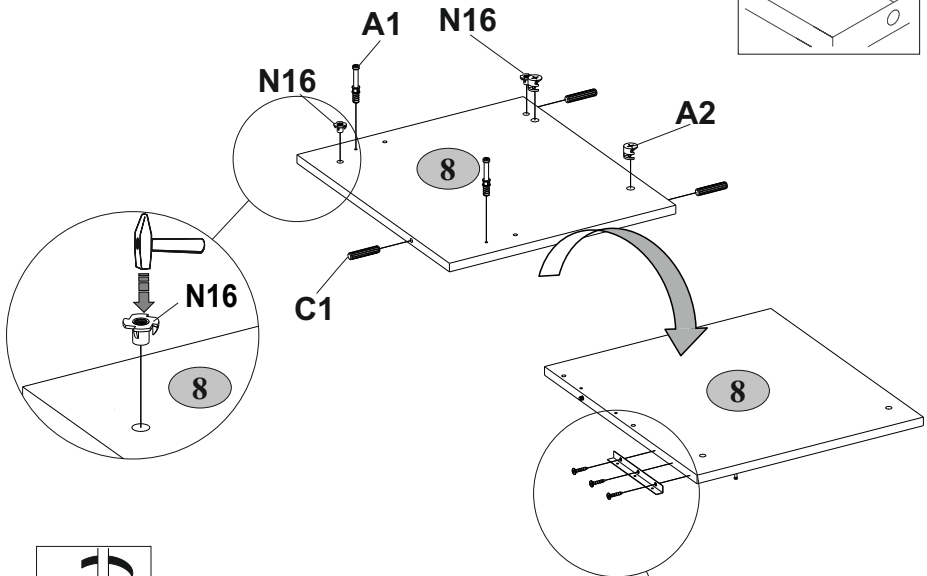
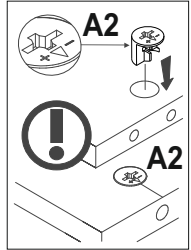
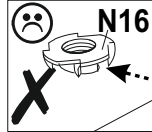
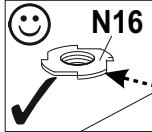
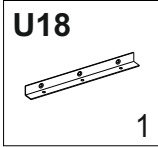
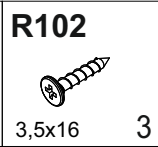
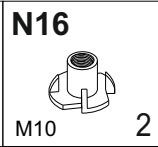
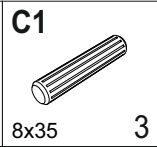
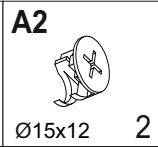
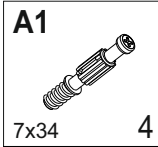

4

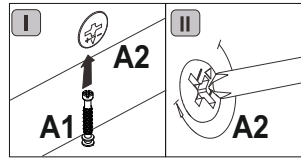
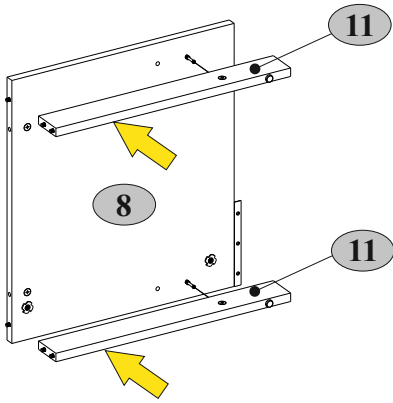

5

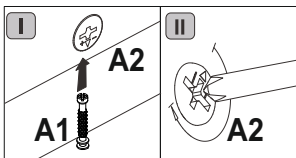
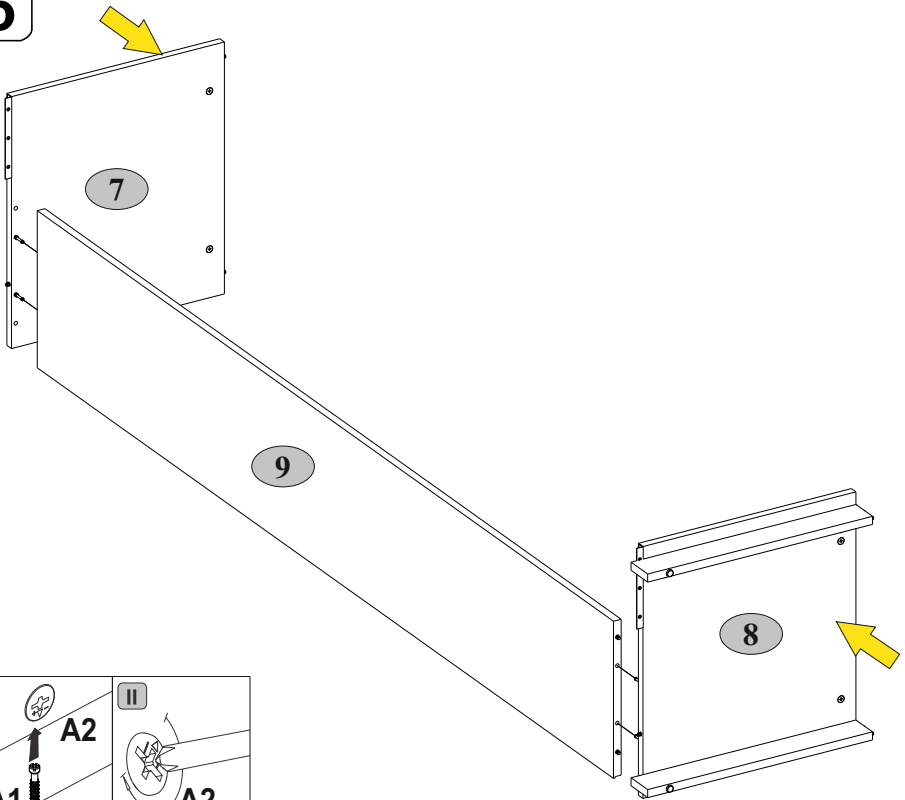

6

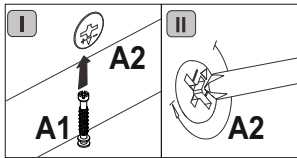
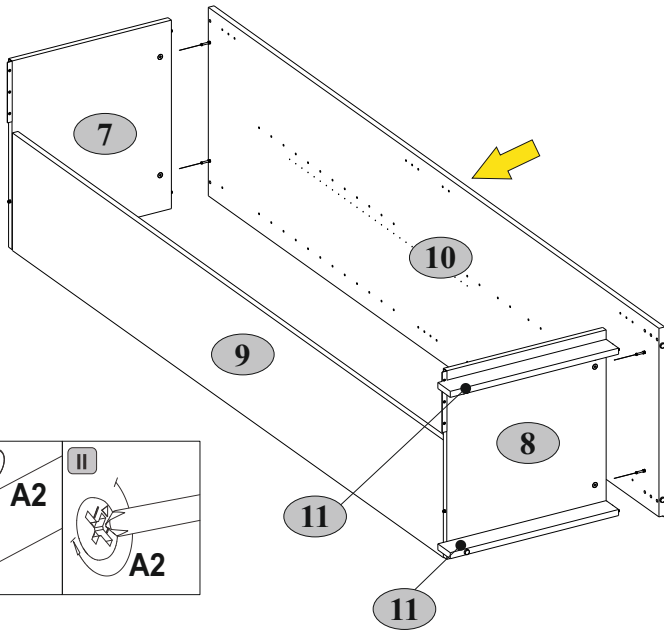

7

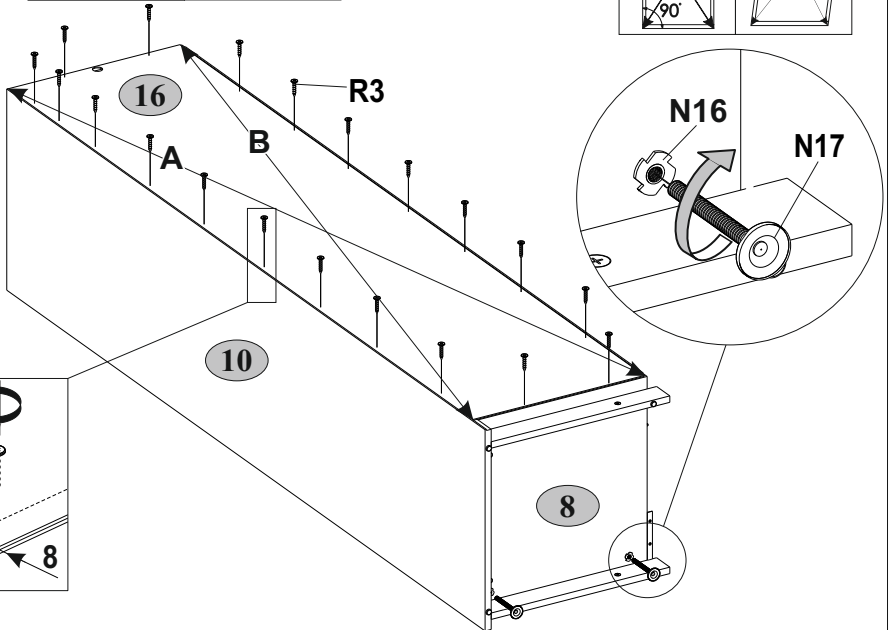
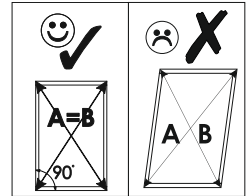
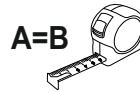
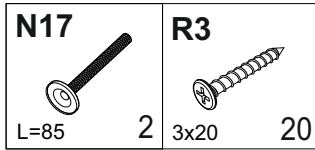

**8****R102**

3,5x16

6

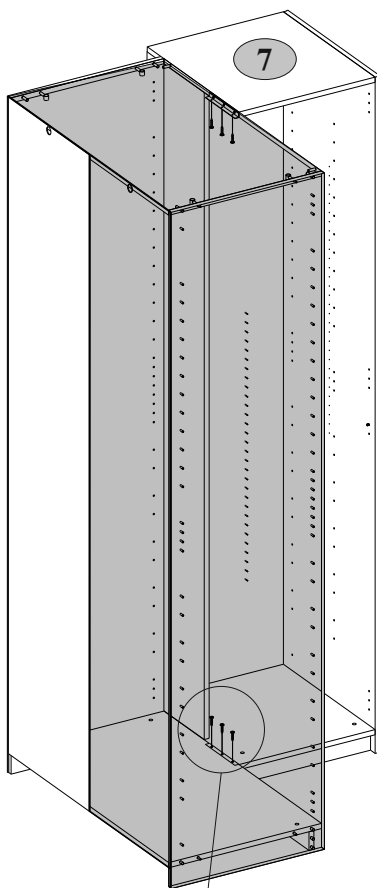
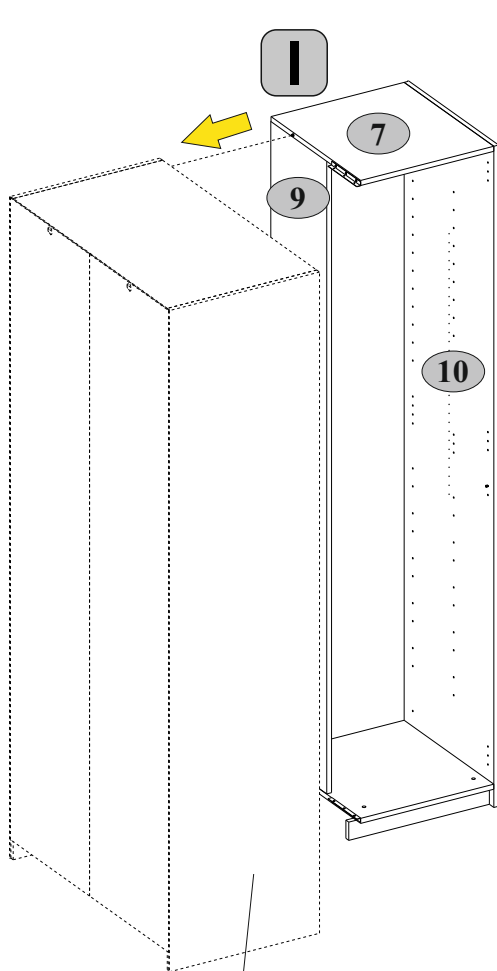

**Корпус шкафа 100/56**  
**Cabinet cupboard 100/56**  
**Korpus szafki 100/56**

AH-056.01.00.00

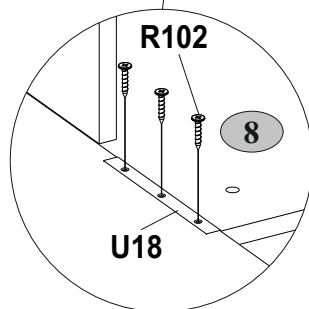

9

**B5**



10x50

1

**I**



S4

1

**R102**



3,5x16

2

**S5**



Ø18

6

**S8-1**



Ø20

2

**U**

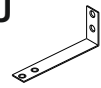

90x35x15

1

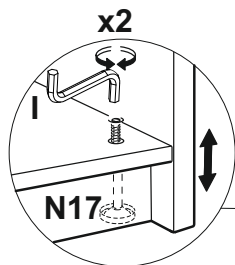
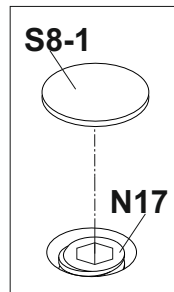
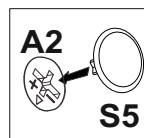
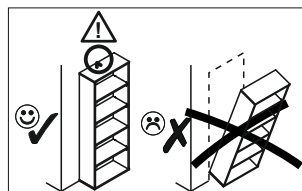
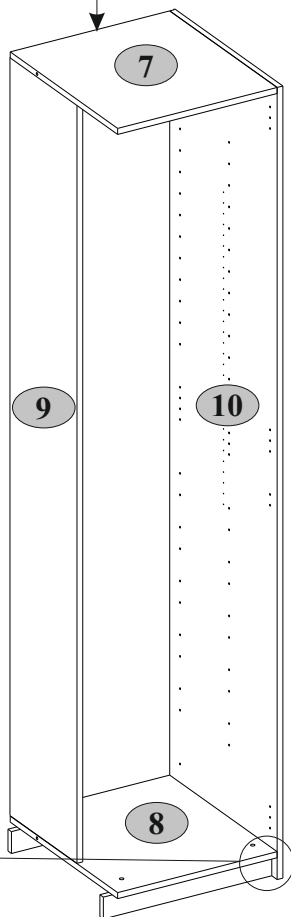
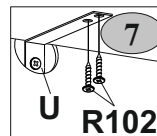
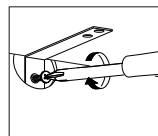
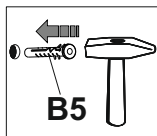
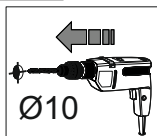
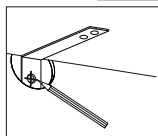

Комплект полок 51/35  
 Zestaw półek 51/35  
 Set of shelves 51/35

AH-056.13.00.00

№ п/п	Длина мм	Ширина мм	Толщина мм	Кол-во шт.	№ пачки
1	481	347	18	3	1/1

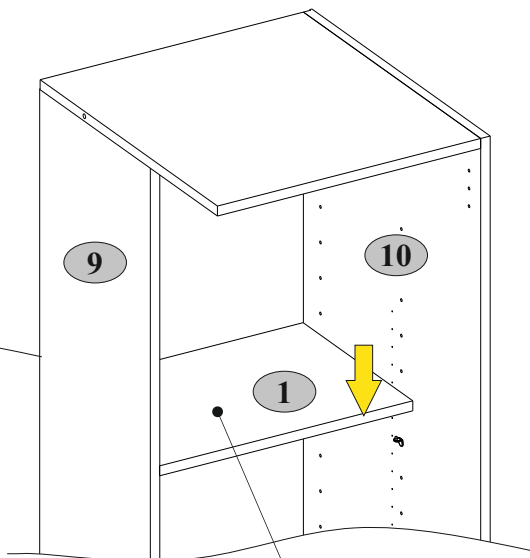
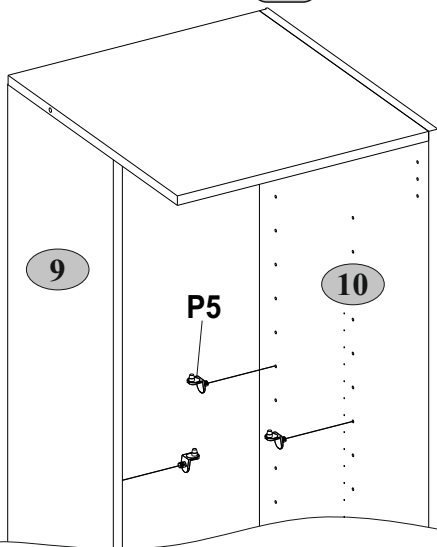
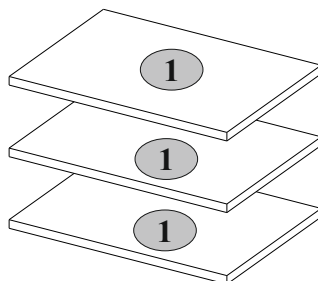
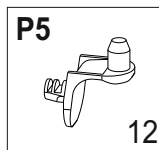







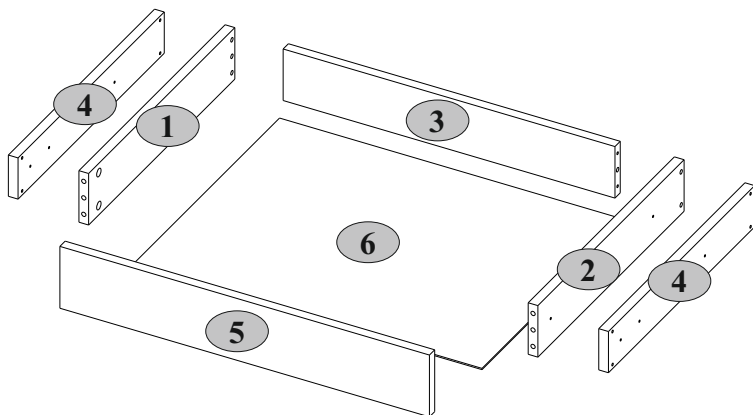



Ящик 51/35  
Szufłada 51/35  
Drawer 51/35

АН-056.18.00.00

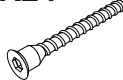



№ п/п	Длина мм	Ширина мм	Толщина мм	Кол-во шт.	№ пачки
1	320	100	18	1	1/1
2	320	100	18	1	1/1
3	383	100	18	1	1/1
4	320	80	18	2	1/1
5	453	120	18	1	1/1
6	417	325	2,5	1	1/1





<b>A1</b>  7x34      4	<b>A2</b>  Ø15x12      4	<b>C1</b>  8x35      4	<b>I</b>  S4      1	<b>Q</b>  1,5x7      2
<b>R3</b>  3x20      8	<b>R24</b>  7x50      4	<b>R27</b>  5,0x13      10	<b>R43</b>  6,3x30      8	<b>S5</b>  Ø18      4
<b>Z10</b>  300      1				

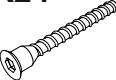

1

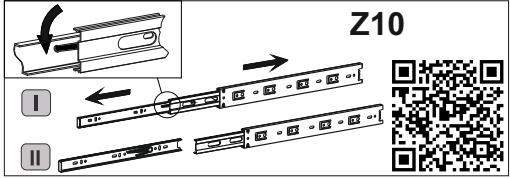
<b>A1</b>  7x34	<b>A2</b>  4 Ø15x12	<b>C1</b>  4 8x35	<b>I</b>  S4	<b>R24</b>  1 7x50
--	--	--	---	---



<b>R27</b>  5,0x13	<b>S5</b>  4 Ø18
---	---

<b>Z10</b>  300	1
--	---

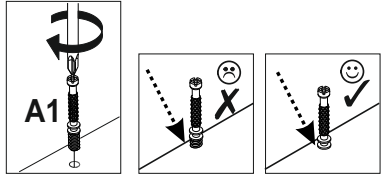
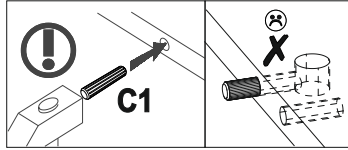
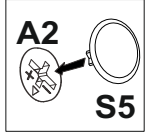
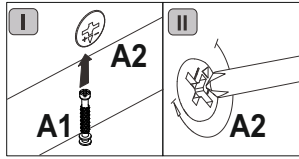
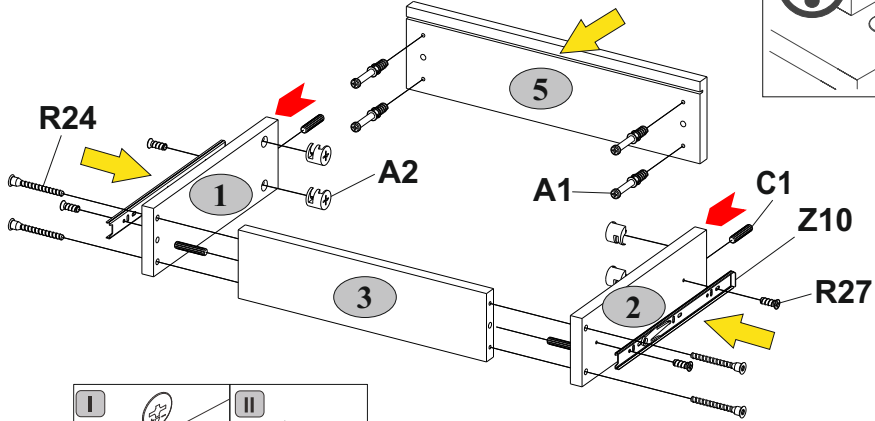
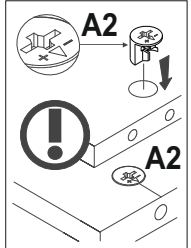
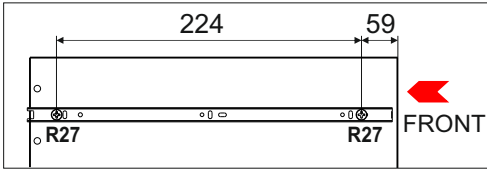
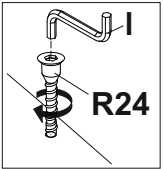

2

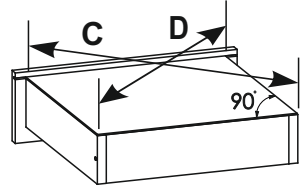
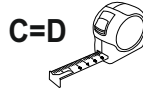
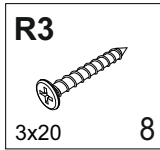

I

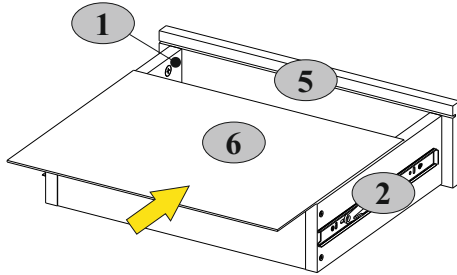

II

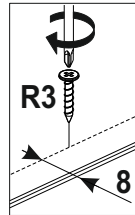
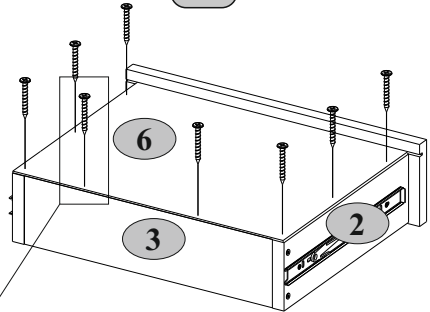

3

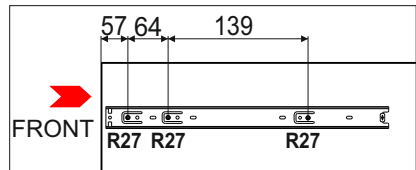
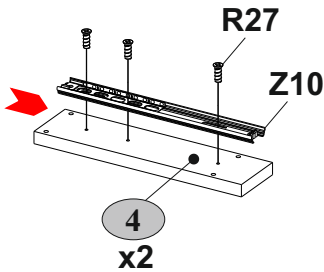
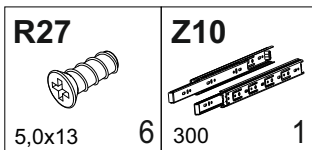

**4**

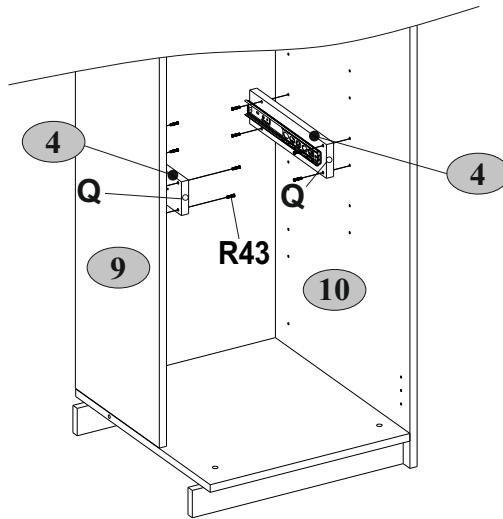
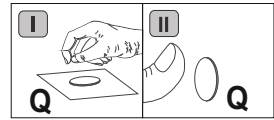
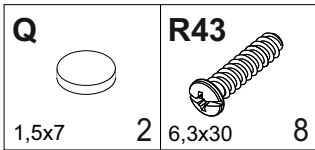

**5**

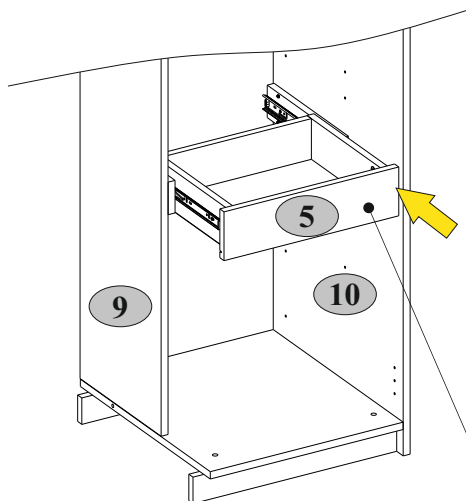

 **max.  
5 kg**

Дверь 50 (F1-1)  
 Drzwi 50 (F1-1)  
 Frontage 50 (F1-1)



АН-056.20.00.00

Дверь 50 (F1-2)  
 Drzwi 50 (F1-2)  
 Frontage 50 (F1-2)





АН-056.21.00.00

№ п/п	Длина мм	Ширина мм	Толщина мм	Кол-во шт.	№ пачки
7	2292	496	19	1	1/2

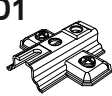
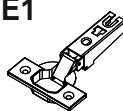

1/2

<b>H35</b> 	<b>M12</b> 
1	2
M4x25	

2/2

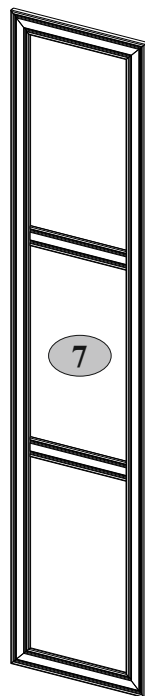

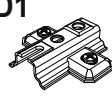
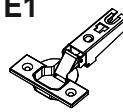

<b>D1</b> 	<b>E1</b> 	<b>Q</b> 
4	4	2
1,5x7		
<b>R23</b> 	<b>R102</b> 	
8	8	
6,3x13		3,5x16

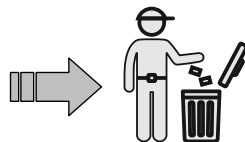

<b>D1</b> 	<b>E1</b> 	<b>R23</b> 
4	4	8
6,3x13		



1

<b>E12</b>  165° 4	<b>H35</b>  1	<b>M12</b>  M4x25 2	<b>R102</b>  3,5x16 8
---	--	--	--

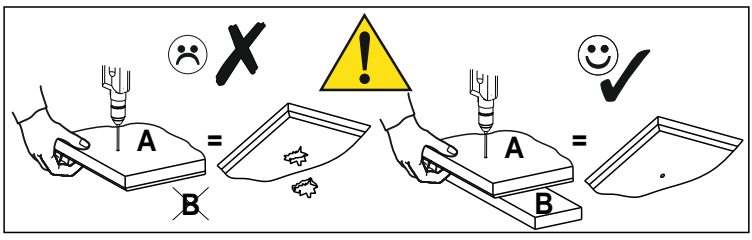
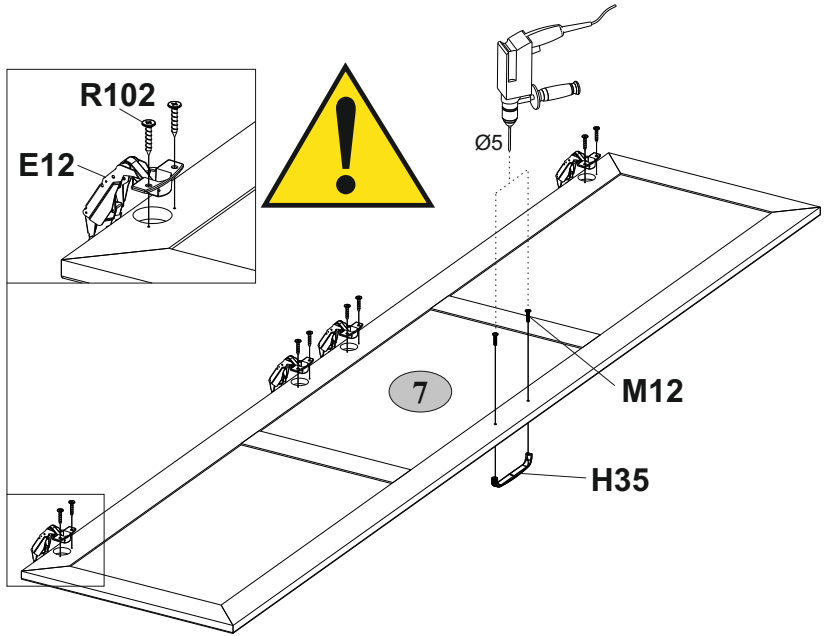
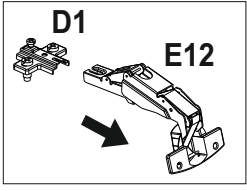



Дверь 50 Z  
 Drzwi 50 Z  
 Frontage 50 Z





АН-056.19.00.00

№ п/п	Длина мм	Ширина мм	Толщина мм	Кол-во шт.	№ пачки
9	2292	496	22	1	1/2

1/2

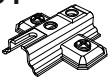
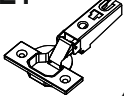

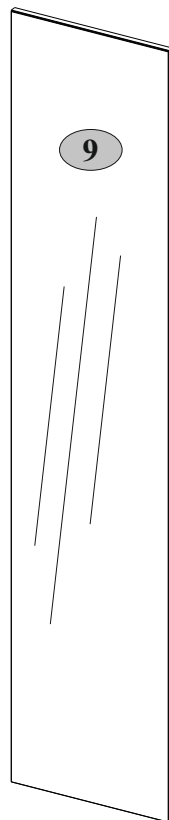

<b>H32</b> 	<b>R102</b> 
1	3,5x16 2

2/2

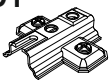
<b>D1</b> 	<b>E1</b> 	<b>Q</b> 
4	4	1,5x7 2
<b>R23</b> 	<b>R102</b> 	
6,3x13 8	3,5x16 8	

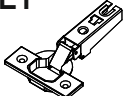

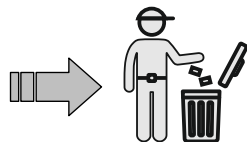

<b>D1</b> 
4

<b>E1</b> 	<b>H32</b> 	<b>R23</b> 	<b>R102</b> 
4	1	6,3x13 8	3,5x16 2



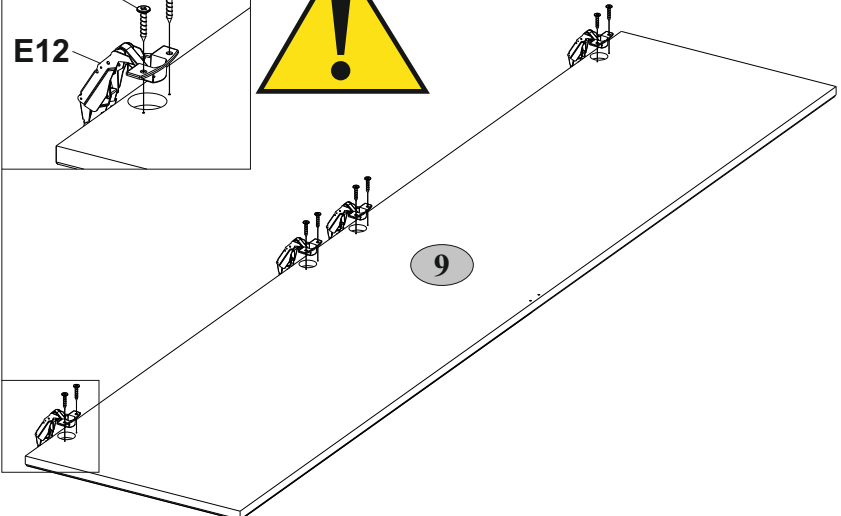
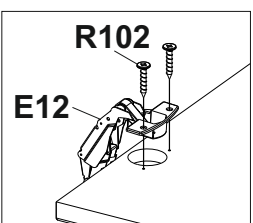
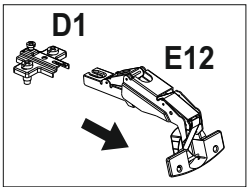

1

<b>E12</b>  165°	<b>R102</b>  3,5x16
4	8

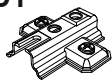

2

<b>D1</b> 	<b>Q</b> 	<b>R23</b> 		
4	1,5x7	2	6,3x13	8

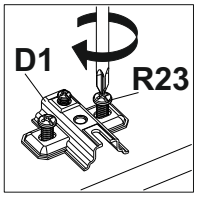
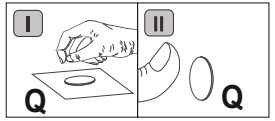
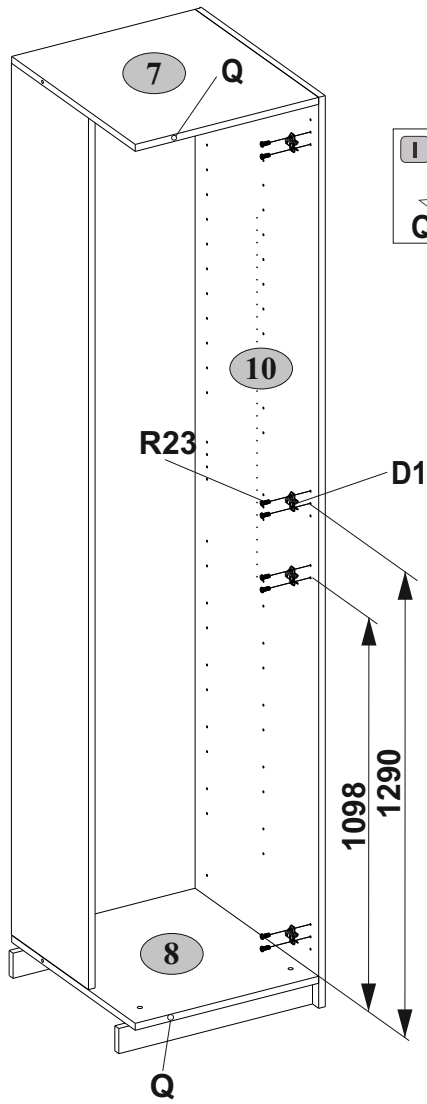



3

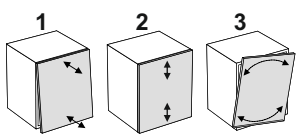
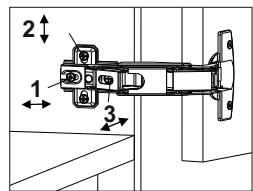
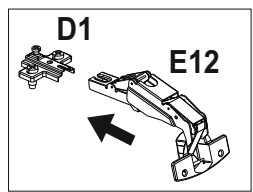
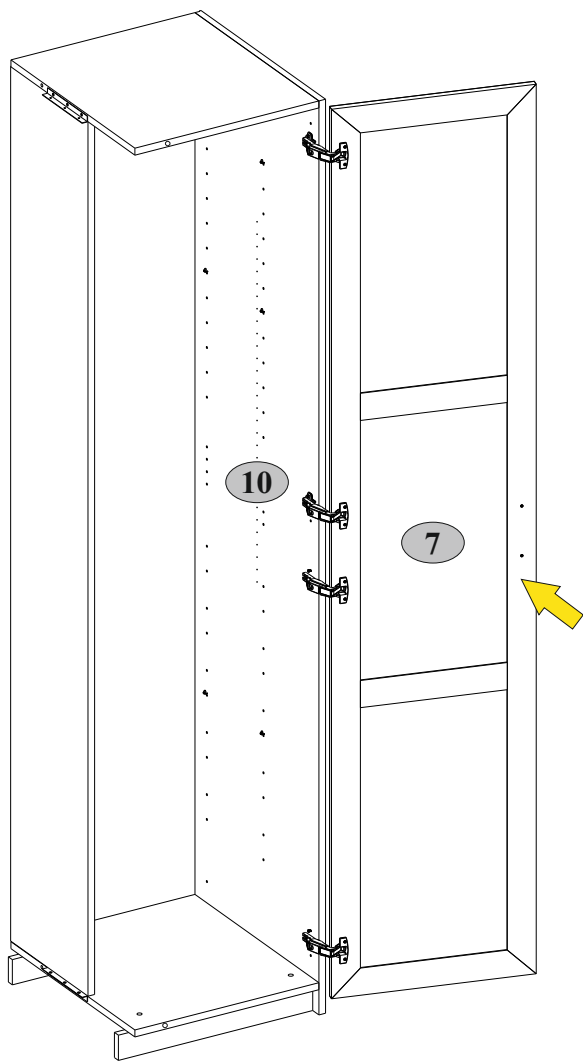

3

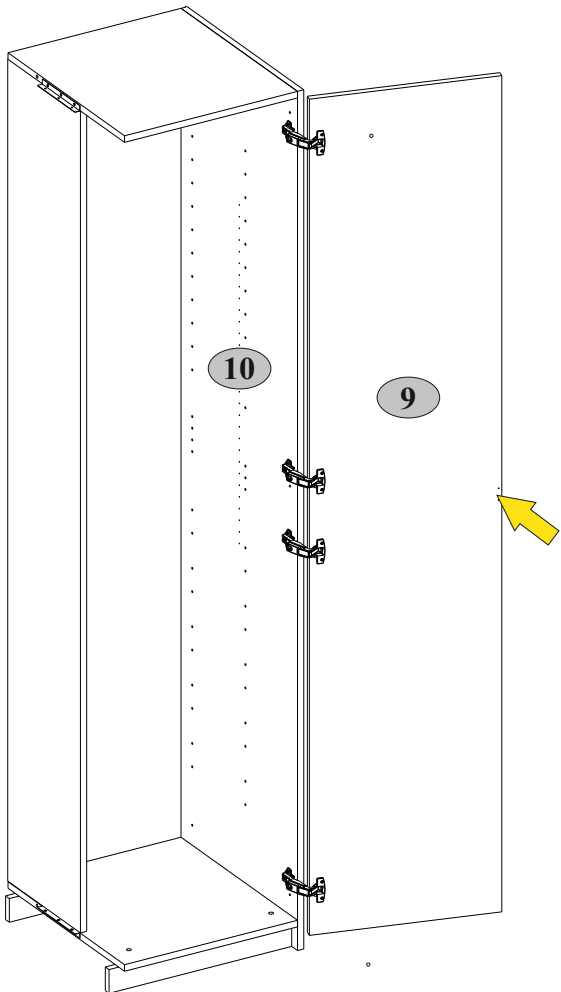
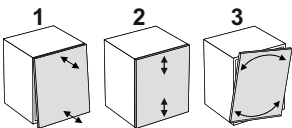
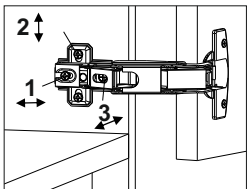
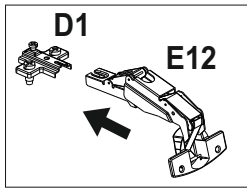

Накладка 56  
Nakładka 56  
Overlay 56

АН-056.30.00.00

№ п/п	Длина мм	Ширина мм	Толщина мм	Кол-во шт.	№ пачки
12	2355	584	16	1	1/1

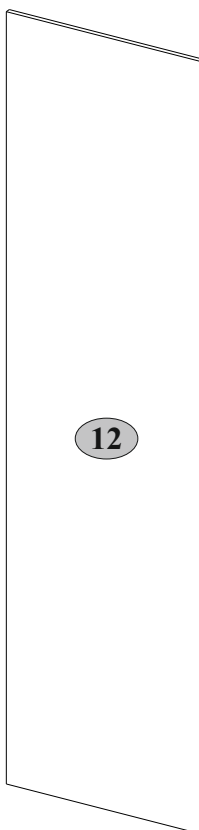
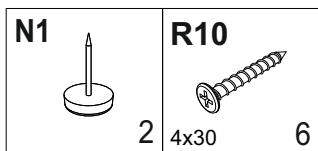

1

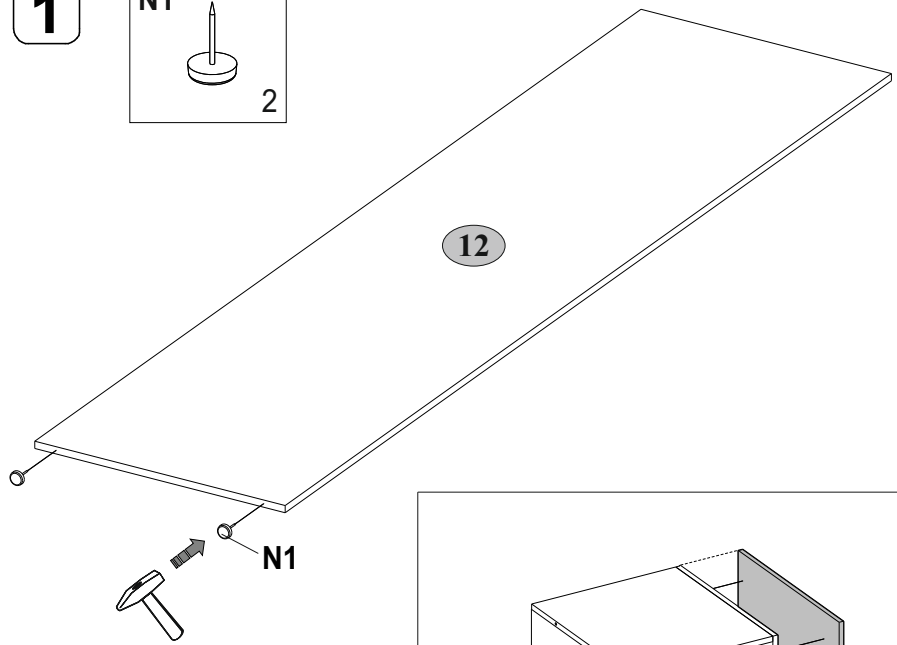
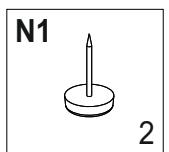

2

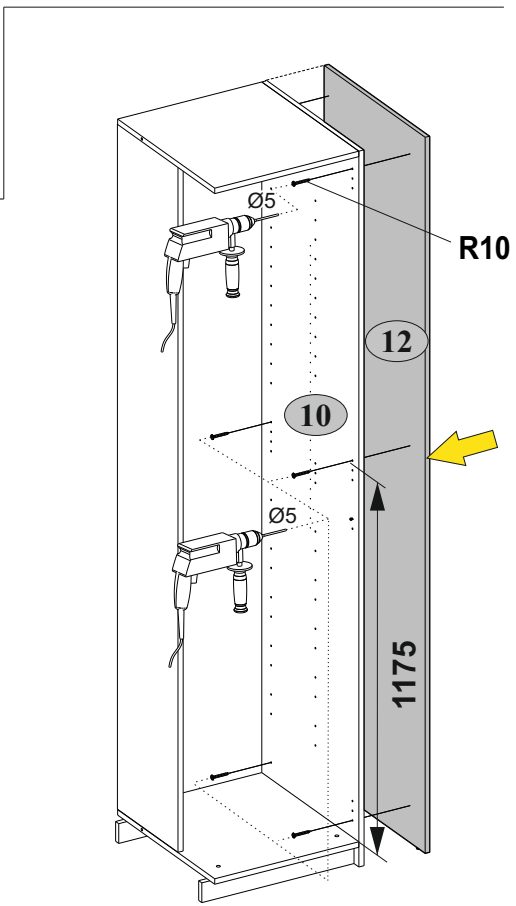
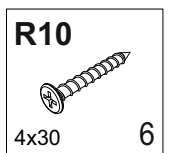

Штанга 51/56  
Sztanga 51/56  
Crossbar 51/56

**R102**



3,5x16

4

**Y1**



2

**Y2**



474

1

**1**

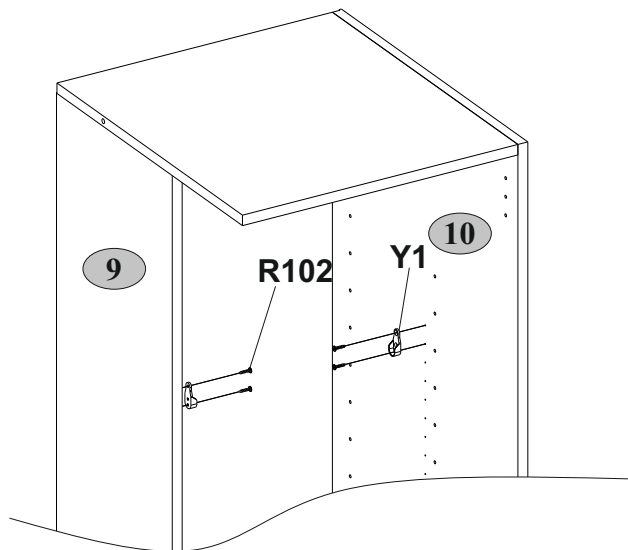

**2**

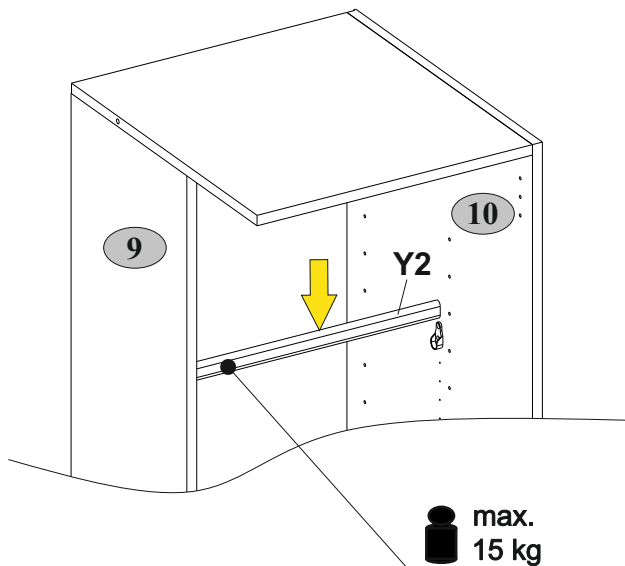

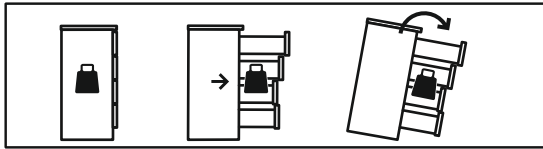

**RU**

**ВНИМАНИЕ!**

Опрокидывание мебели может стать причиной получения серьезных травм и привести к смерти.

Чтобы предотвратить опрокидывание, **ВСЕГДА** крепите мебель к стене с помощью фурнитуры, предотвращающей опрокидывание.

В целях принятия мер дополнительной безопасности для предотвращения опрокидывания:

- Храните тяжелые предметы в нижнем ящике.
- Не ставьте тяжелые предметы сверху.
- Никогда не позволяйте детям залезать на ящики, дверцы или полки, а также виснуть на них.
- Используйте мебель по своему прямому назначению.

**PL**

**OSTRZEŻENIE!**

Przewrócenie się mebla może spowodować poważne lub śmiertelne obrażenia ciała na skutek przygniecenia.

**ZAWSZE** przymocuj ten mebel do ściany za pomocą ograniczników.

Aby dodatkowo ograniczyć ryzyko poważnych obrażeń ciała i śmierci na skutek przewrócenia się mebla:

- Najcięższe przedmioty umieść w dolnej szufladzie.
- Nie kładź na wierzchu ciężkich przedmiotów.
- Nigdy nie pozwalaj dzieciom wspinać się na szuflady, drzwiczki lub półki.
- Używaj mebli zgodnie z ich przeznaczeniem.

**EN**

**WARNING!**

Serious or fatal crushing injuries can occur from furniture tip-over.

**ALWAYS** secure this furniture to the wall using tip-over restraints.

To further reduce the risk of serious injury and death from tip-overs:

- Place heaviest items in the lower drawer.
- Do not heave objects on top of this product.
- Never let children climb or hang on drawers, doors, or shelves.
- Use the furniture for its intended purpose.